

NEWS 2022



**Alf DaFre®**

NEWS 2022



**Alf DaFre®**

IT ALF DAFRÈ PRESENTA I NUOVI PRODOTTI 2022, DAL DESIGN ESSENZIALE E CURATO NEI MINIMI DETTAGLI. LA RICERCA CONTINUA CON NUOVE FINITURE, COORDINABILI SU VARIE TIPOLOGIE DI PRODOTTO E ARREDO DELLA CASA.

EN ALF DAFRÈ PRESENTS ITS NEW PRODUCTS FOR 2022: SIMPLE DESIGNS WITH SUPERB ATTENTION TO DETAIL. THE JOURNEY CONTINUES WITH NEW FINISHES, FOR A COORDINATED LOOK ACROSS PRODUCT TYPES AND HOME FURNISHINGS.



Nobu → p. 28



Yukio → p. 24



Righetto → p. 8



Poker total view → p. 4



Day collection → p. 16



Tsuki → p. 32

IT POKER TOTAL VIEW  
NUOVO MODULO  
AD APERTURA TOTALE  
EN POKER TOTAL VIEW  
NEW FULLY OPEN UNIT





**Poker armadio**  
Ante Laccato opaco Tortora /  
Attrezzature interne e schienali  
nobilitato Noce naturale / Interno  
nobilitato Oxford Sand

**Poker wardrobe**  
Doors in matt Tortora lacquer /  
Internal fittings and back panels in  
Naturale walnut surfaced finish /  
Interiors in Oxford Sand surfaced finish

IT RIGHETTO LETTO  
CON BOISERIE  
IN LEGNO  
ATTREZZABILE  
EN RIGHETTO BED  
WITH WOODEN  
PANELLING  
AND ACCESSORIES









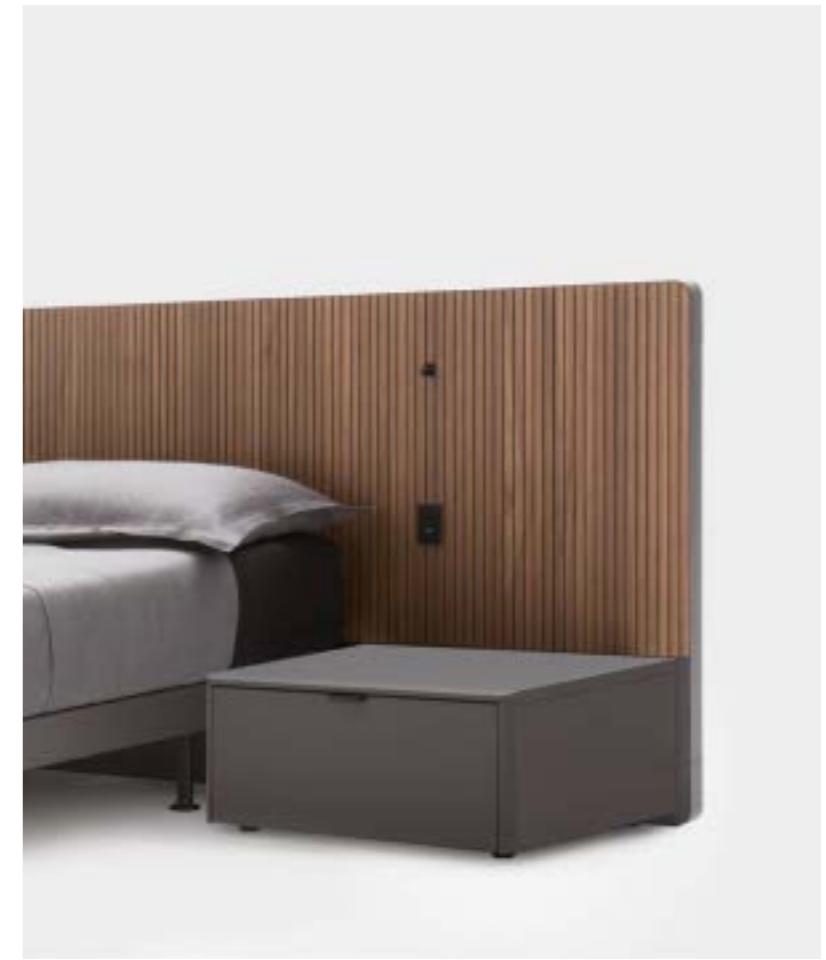
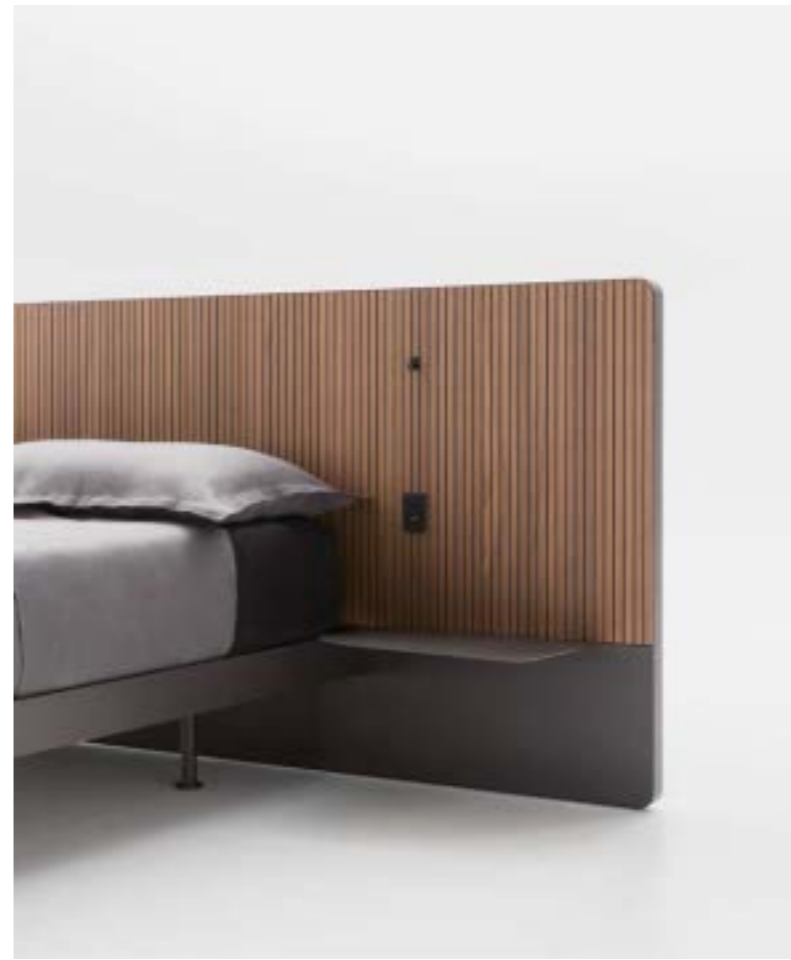

**Righetto letto**  
Groove Noce naturale  
Laccato opaco Moka Shine  
L296 P207,4 H100

**Righetto bed**  
Groove Naturale walnut  
Matt Moka Shine lacquer  
W296 D207.4 H100

**Timeless gruppo notte**  
Laccato opaco Moka Shine  
L60 P45 H30,9

**Timeless bedroom units**  
Matt Moka Shine lacquer  
W60 D45 H30.9

IT DA OGGI GLI SCHIENALI  
DEL PROGRAMMA DAY  
COLLECTION SONO  
DISPONIBILI NELLE NUOVE  
FINITURE GROOVE  
EN THE BACK PANELS  
IN THE DAY COLLECTION  
ARE NOW AVAILABLE  
IN THE NEW GROOVE  
FINISHES





Day collection  
 Basi sospese laccato opaco Fango /  
 Schienali Groove Fashion wood rovere  
 Carbone / Pensile CUBE laccato opaco  
 Fango / Pensili laccato lucido Fango /  
 Mensole metallo verniciato Moka Shine  
 L480 P52,4 H144

Day collection  
 Wall-mounted base units lacquered in  
 matt Fango / Back panels Groove Fashion  
 wood rovere Carbone / CUBE wall units  
 lacquered in matt Fango / Wall units high  
 gloss Fango lacquered / Metal shelves  
 painted in Moka Shine. W480 D52,4 H144



**Day collection**  
Basi, Pensili e Pensili WING laccato opaco  
Tortora / Schienali Groove Fashion wood  
rovere Canapa / Mensole metallo verniciato  
Moka Shine  
L480 P44 H184

**Day collection**  
Base units, wall units and WING wall units  
lacquered in matt Tortora / Back panels in  
Groove Fashion Wood Canapa oak / Metal  
shelves painted in Moka Shine  
W480 D44 H184



**Day collection**  
 Basi sospese laccato Piombo opaco /  
 Pensili CUBE laccato opaco Piombo e Box  
 interni rivestiti in cuoio 1031 / Schienali  
 Groove Noce Naturale / Mensola metallo  
 verniciato Moka Shine  
 L448 P34,4 H128

**Day collection**  
 Wall-mounted base units lacquered in matt  
 Piombo / CUBE wall units lacquered in matt  
 Piombo and Box Interiors covered in leather  
 1031 / Back panels in Groove Naturale  
 walnut / Metal shelf painted in Moka Shine  
 W448 D34.4 H128



IT YUKIO  
SCRITTOIO CON  
PIANO APRIBILE  
EN YUKIO LIFT  
TOP DESK





**Yukio scrittoio**  
Struttura verniciato Moka Shine /  
Piano Fashion wood rovere Fossile  
L 142,3 P 62,5 H 79,8



**Yukio desk**  
Structure painted in Moka Shine /  
Fashion Wood Fossile oak top  
W142.3 D62.5 H79.8

IT NOBU  
CONTENITORE  
TRASFORMISTA  
EN NOBU MULTI-  
PURPOSE  
STORAGE UNIT







**Nobu contenitore**  
Tessuto Antibes 904 / Vassoio Nickel SG  
L38,6 P42,6 H44

**Nobu box unit**  
Antibes 904 fabric / Tray Nickel SG  
W38,6 D42,6 H44

IT TSUKI TAVOLINI CON  
STRUTTURA METALLO  
E PIANO VETRO  
EN TSUKI OCCASIONAL  
TABLES WITH METAL  
FRAME AND GLASS TOP





**Tsuki tavolini**  
Struttura verniciato moka shine /  
Piano vetro bronzo satinato  
L101,7 P99,8 H28  
L104,5 P76,8 H35  
L60 P54,3 H42

**Tsuki occasional tables**  
Structure painted in Moka Shine /  
Satin-finish bronze glass top  
W101,7 D99,8 H28  
W104,5 D76,8 H35  
W60 D54,3 H42

IT NUOVI PIEDI IN  
METACRILATO  
TRASPARENTE  
EN NEW CLEAR  
METHACRYLATE  
FEET



Nuovi piedi in metacrilato trasparente che donano la sensazione di dormire su un letto sospeso. Disponibile per le piattaforme P18, P24 e P25

New clear methacrylate feet that create the feel of sleeping on a floating bed. Available for platforms P18, P24 and P25



**Poker armadio**  
Ante laccato opaco Tortora / Attrezzature interne e schienali nobilitato Noce naturale / Interno nobilitato Oxford Sand

**Poker wardrobe**  
Doors in matt Tortora lacquer / Internal fittings and back panels in Naturale walnut surfaced finish / Interiors in Oxford Sand surfaced finish



**Day collection**  
Basi sospese laccato Piombo opaco / Pensili CUBE laccato opaco Piombo e Box interni rivestiti in cuoio 1031 / Schienali Groove Noce Naturale / Mensola metallo verniciato Moka Shine  
L448 P34,4 H128

**Day collection**  
Wall-mounted base units lacquered in matt Piombo / CUBE wall units lacquered in matt Piombo and Box Interiors covered in leather 1031 / Back panels in Groove Naturale walnut / Metal shelf painted in Moka Shine  
W448 D34.4 H128



**Yukio scrittoio**  
Struttura verniciato Moka Shine / Piano Fashion wood rovere Fossile  
L 142,3 P62,5 H79,8

**Yukio desk**  
Structure painted in Moka Shine / Fashion Wood Fossile oak top  
W142.3 D62.5 H79.8



**Day collection**  
Basi sospese laccato opaco Fango / Schienali Groove Fashion wood rovere Carbone / Pensile CUBE laccato opaco Fango / Pensili laccato lucido Fango / Mensole metallo verniciato Moka Shine  
L480 P52,4 H144

**Day collection**  
Wall-mounted base units lacquered in matt Fango / Back panels Groove Fashion wood rovere Carbone / CUBE wall units lacquered in matt Fango / Wall units high gloss Fango lacquered / Metal shelves painted in Moka Shine. W480 D52,4 H144



**Day collection**  
Basi, Pensili e Pensili WING laccato opaco Tortora / Schienali Groove Fashion wood rovere Canapa / Mensole metallo verniciato Moka Shine  
L480 P44 H184

**Day collection**  
Base units, wall units and WING wall units lacquered in matt Tortora / Back panels in Groove Fashion Wood Canapa oak / Metal shelves painted in Moka Shine  
W480 D44 H184

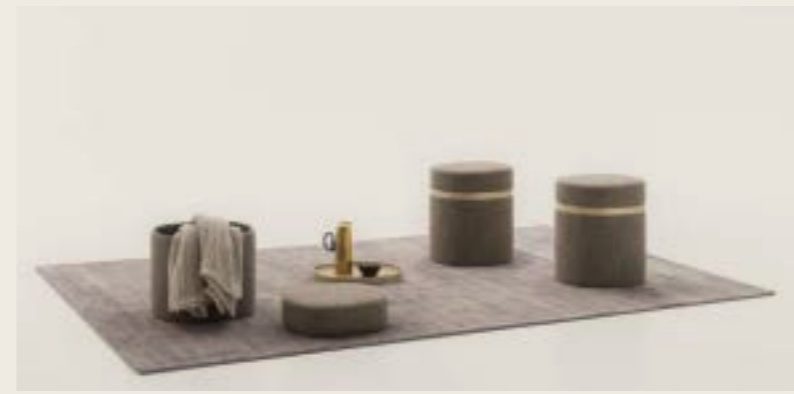

**Nobu contenitore**  
Tessuto Antibes 904 / Vassoio Nickel SG  
L38,6 P42,6 H44

**Nobu box unit**  
Antibes 904 fabric / Tray Nickel SG  
W38,6 D42,6 H44



**Nobu contenitore**  
Tessuto Antibes 606 / Vassoio Nickel SG  
L38,6 P42,6 H38

**Nobu box unit**  
Antibes 606 fabric / Tray Nickel SG  
W38,6 D42,6 H44



**Righetto letto**  
Groove Noce naturale  
Laccato opaco Moka Shine  
L296 P207,4 H100

**Righetto bed**  
Groove Naturale walnut  
Matt Moka Shine lacquer  
W296 D207.4 H100

Accessori Righetto: faretto led direzionale con accensione touch e presa usb, mensola in metallo.

Righetto accessories: adjustable LED spotlight with touch switch and USB socket, and a metal shelf.



**Nuovi piedi in metacrilato trasparente** che donano la sensazione di dormire su un letto sospeso. Disponibile per le piattaforme P18, P24 e P25

**New clear methacrylate feet** that create the feel of sleeping on a floating bed. Available for platforms P18, P24 and P25



**Tsuki tavolini**  
Struttura verniciato moka shine / Piano vetro bronzo satinato  
L101,7 P99,8 H28  
L104,5 P76,8 H35  
L60 P54,3 H42

**Tsuki occasional tables**  
Structure painted in Moka Shine / Satin-finish bronze glass top  
W101,7 D99,8 H28  
W104,5 D76,8 H35  
W60 D54,3 H42

# POKER

Poker total view è un nuovo modulo "doppio" con divisione centrale rientrante per una migliore fruibilità dello spazio interno grazie anche all'innovativo sistema di apertura delle ante a pacchetto.

Poker Total View is a new double unit with a recessed central partition and innovative folding door mechanism, to make the best use of the internal space.

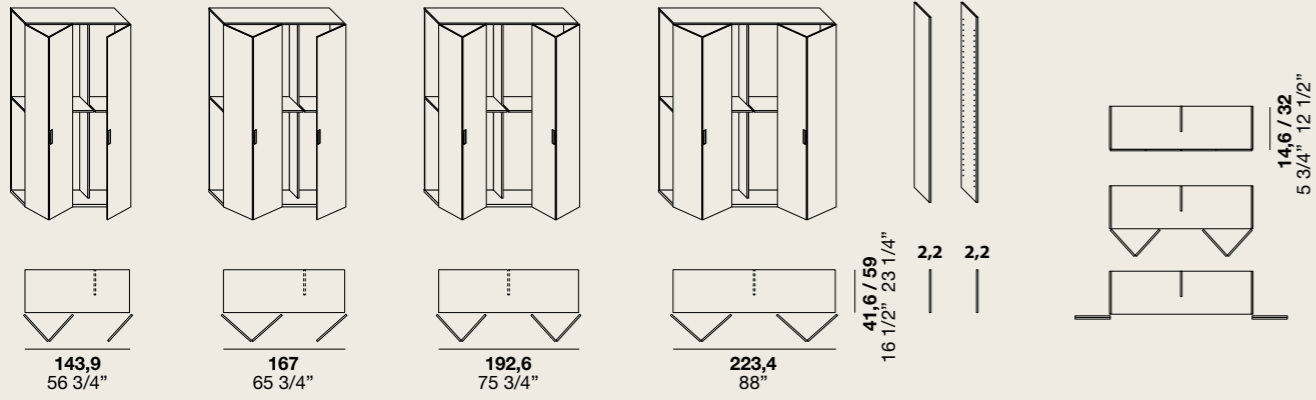

## IT NUOVI ABBINAMENTI SCOCCA E ATTREZZATURE INTERNE EN NEW MATCHING BODY AND INTERNAL FITTING FINISHES

\* Nel caso di finitura Oxford sand i bordi di coperchi, fondi e divisioni sono sempre finitura Moka Shine.  
For the Oxford Sand finish, the top, bottom and partition edges are finished in Moka Shine.

IT FINITURE COPERCHIO, FONDO,  
DIVISIONE  
EN TOP, BOTTOM AND PARTITION  
FINISHES

C - D - E

IT FINITURE RIPIANI, SCHIENE,  
ATTREZZATURA INTERNA  
EN SHELF, BACK AND INTERNAL  
FITTING FINISHES

A - B - C - D - E

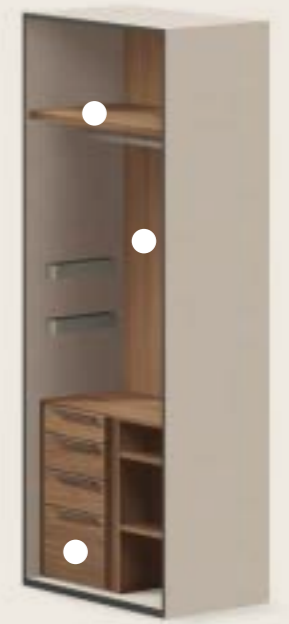

**NUOVA MANIGLIA I22**  
Per modulo Total view e ante Even

**NEW HANDLE I22**  
For Total View unit and Even doors

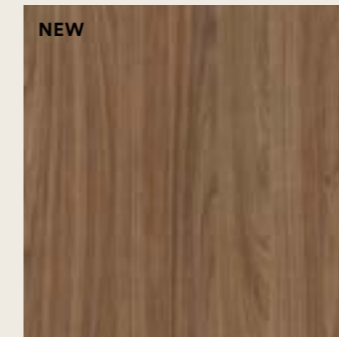

**A - NOBILITATO  
NOCE NATURALE NNN**

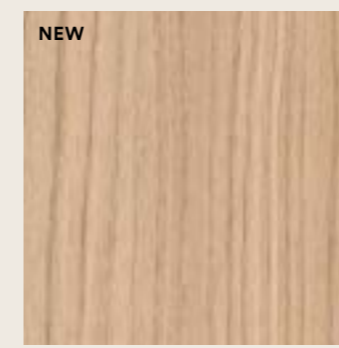

**B - NOBILITATO  
ROVERE CHIARO NRC**



**C - NOBILITATO  
OXFORD SAND \* NOS**



**D - NOBILITATO  
TRAMA COLONIALE NTC**



**E - NOBILITATO  
TRAMA GESSO NTG**

## DAY COLLECTION / ANTIS

Gli schienali e i frontali del programma Day Collection e i frontali del programma Antis sono disponibili nelle nuove finiture Groove.

The front and the back panels in the Day collection and the front in the Antis collection are available in the new Groove finishes.

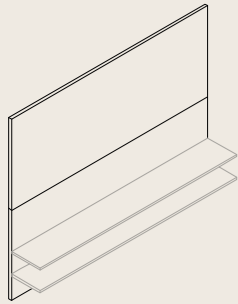

● Schienali  
Wall panels

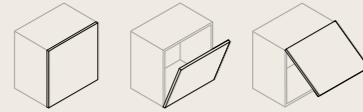

● Pensili e basi  
Base and wall units



## IT NUOVA FINITURA GROOVE IN 9 ESSENZE LEGNO EN NEW GROOVE FINISH IN 9 WOOD GRAINS

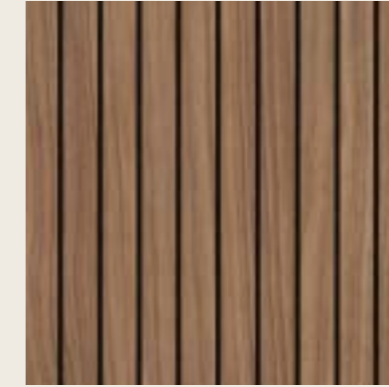

GROOVE  
NOCE NATURALE

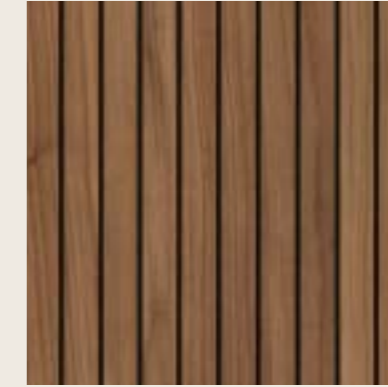

GROOVE  
NOCE CLASSICO

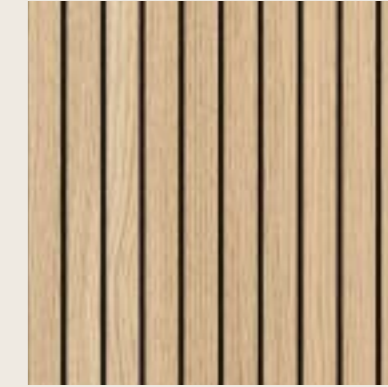

GROOVE FASHION WOOD  
ROVERE NATURALE



GROOVE FASHION WOOD  
ROVERE CANAPA

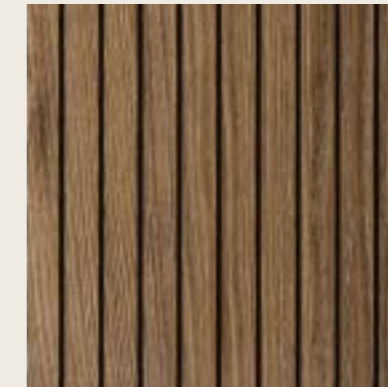

GROOVE FASHION WOOD  
ROVERE BISCOTTO

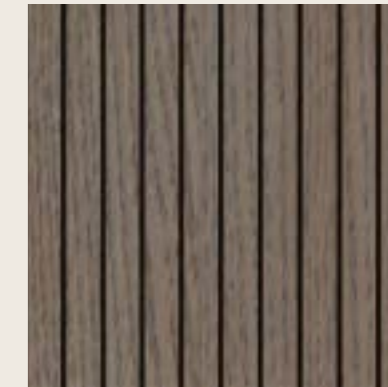

GROOVE FASHION WOOD  
ROVERE GHIRO

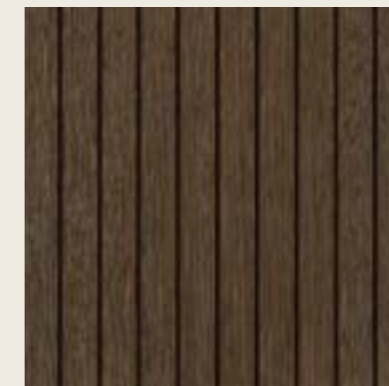

GROOVE FASHION WOOD  
ROVERE TERRA

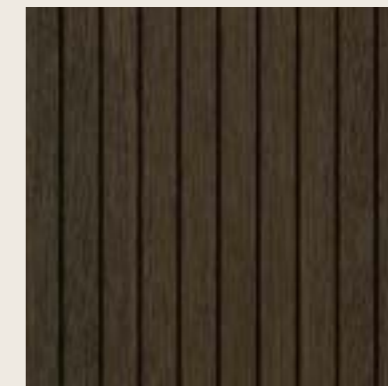

GROOVE FASHION WOOD  
ROVERE CARBONE



GROOVE FASHION WOOD  
ROVERE FOSSILE

# RIGHETTO

design Bruna Vaccher

Righetto è un letto con testiera legno attrezzabile con faretto e mensola metallo, piattaforma legno con piedini metallo. La testiera con profilo perimetrale in alluminio ha due finiture, una per la parte superiore, l'altra in abbinamento alla piattaforma.

Righetto is a bed with a wooden headboard that can be fitted with a spotlight and metal shelf, and a wooden platform with metal feet. The headboard with an aluminium perimeter profile features two finishes, one for the upper part and one to match the platform.

## Materiali e finiture

Pannello superiore testiera Groove Noce, Groove Fashion wood.

Pannello inferiore testiera e piattaforma laccato Moka Shine.

## Materials and finishes

Upper headboard panel: walnut Groove and Groove Fashion Wood.

Lower headboard panel and platform: Moka Shine lacquer.

## Misure

### Measurements

L296 P207,4 H100

L316 P207,4 H100

## Vano rete

### Inner spring support size

160,5 X 200,5

180,5 X 200,5

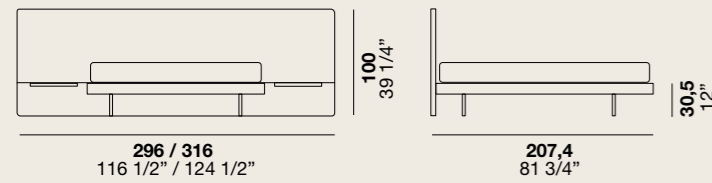

# YUKIO

design Gordon Guillaumier

Registered design

Yukio è uno scrittoio con struttura metallo e piano in legno apribile con vano porta oggetti.

Yukio is a desk with a metal frame and wooden top that opens with a storage compartment beneath.

## Materiali e finiture

Struttura verniciato Moka Shine o Anfora. Piano Noce naturale, Noce classico e Fashion wood.

## Materials and finishes

Frame painted in Moka Shine or Anfora. Naturale and Classico walnut top and Fashion Wood.

Tappetino in Cuoio 1004 di serie e specchio opzionale.

Leather 1004 mat as standard and optional mirror.

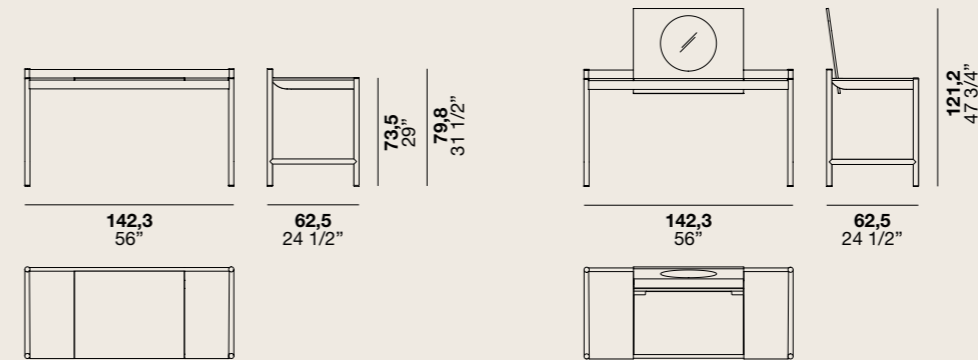



# NOBU

design Raffaella Mangiarotti

Nobu è un contenitore imbottito con cuscino removibile che "cela" un vassoio in poliuretano rigido.

Nobu is an upholstered storage unit with a removable cushion that "conceals" a rigid polyurethane tray.

## Materiali e finiture

Rivestimento: Tessuti / Pelle / Ecopelle  
Vassoio: Laccato Moka Shine / Laccato micalizzato Nickel SG.

## Materials and finishes

Upholstery: Fabric / Leather / Ecoleather  
Tray: Moka Shine lacquer / Nickel SG micalised lacquer.

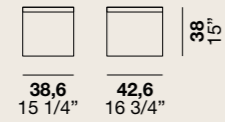
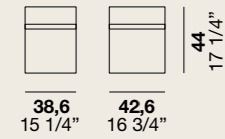

# TSUKI

design Gordon Guillaumier

Registered design

Tsuki è una linea di tavolini con struttura metallo e piano in vetro temprato e filo tondo satinato.

Tsuki is a range of occasional tables with a metal frame, tempered-glass top and rounded satin-finished edge.

## Materiali e finiture

Struttura verniciato Moka Shine  
Piano vetro bronzo satinato.

## Materials and finishes

Frame painted in Moka Shine  
Satin-finish bronze glass top.

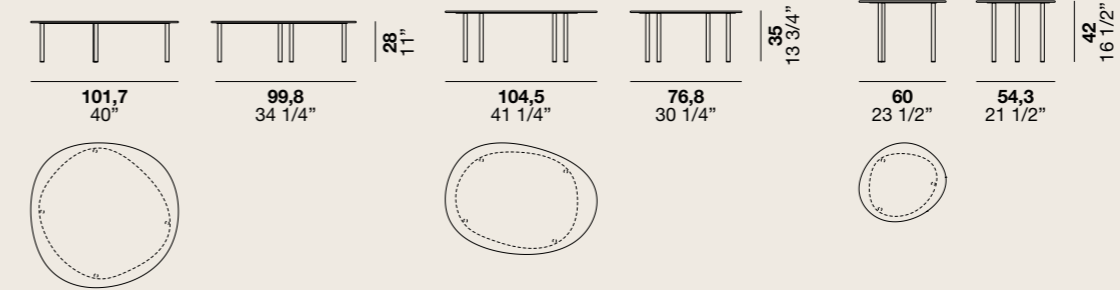



## GORDON GUILLAUMIER

<sup>IT</sup> Gordon Guillaumier nasce nel 1966. Studia a Malta, in Svizzera, in Inghilterra e in Italia. Si diploma in industrial design presso lo IED di Milano (1988-1991) ottenendo successivamente un master in industrial design presso la Domus Academy, Milano (1992). Nel 1993 dopo l'apprendistato presso Baleri Associati, collabora con Rodolfo Dordoni, disegnando i suoi primi pezzi. Nel 2002 apre il proprio studio, occupandosi di design consulting, product and interior design. Ha collaborato con Azzurra Ceramiche, Bosa, Ceramiche Piemme, Desalto, DeSede, Driade, FontanaArte, Foscarini, Gebruder Thonet, Frag, Matteo Grassi, Minotti, Moroso, Oluce, Pamar, Paola C, Roda, Tacchini. Tra i suoi vari riconoscimenti ricevuti sono: Interzum 2011 Award, Wallpaper Design Award 2014, Compasso d'Oro 2016. Le sue opere di interior design e architettura, pubblicate dalle più prestigiose riviste e libri del settore, si concentrano principalmente su progetti residenziali privati. Ha insegnato presso la facoltà di design industriale del Politecnico di Milano e professore in visita all'Abadir Design Academy di Catania. La sua collaborazione per Alf Da Frè per cui firma numerosi progetti inizia nel 2017.

<sup>EN</sup> Gordon Guillaumier was born in 1966. He studied in Malta, Switzerland, England and Italy. He graduated in industrial design from the IED in Milan (1988-1991) and obtained a master's degree in industrial design from the Domus Academy in Milan (1992). In 1993, after his apprenticeship at Baleri Associati, he collaborated with Rodolfo Dordoni, designing his first pieces. In 2002, he opened his own studio where he offers product and interior design services and design consulting. He has collaborated with Azzurra Ceramiche, Bosa, Ceramiche Piemme, Desalto, DeSede, Driade, FontanaArte, Foscarini, Gebruder Thonet, Frag, Matteo Grassi, Minotti, Moroso, Oluce, Pamar, Paola C, Roda and Tacchini. He has received various awards including the Interzum 2011 Award, the Wallpaper Design Award 2014, and the Compasso d'Oro 2016. His interior design and architectural works, published in some of the most prestigious magazines and books in the field, mainly focus on private residential projects. He has taught at the Faculty of Industrial Design at Milan's Polytechnic university and is a visiting professor at the Abadir Design Academy in Catania. He began collaborating with Alf Da Frè in 2017 and has designed numerous projects.

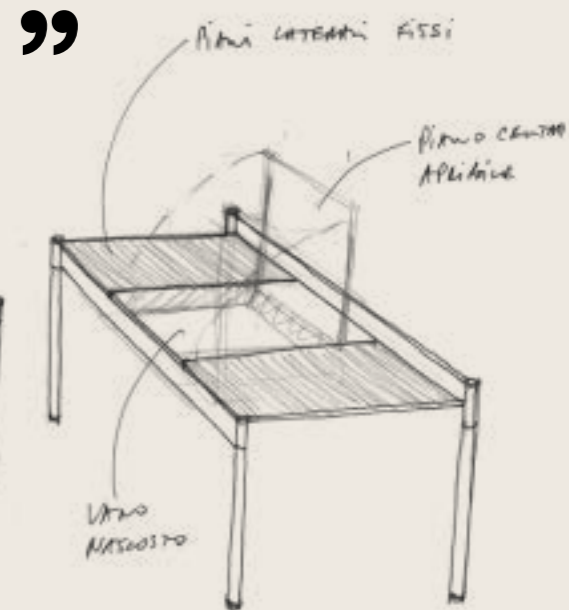
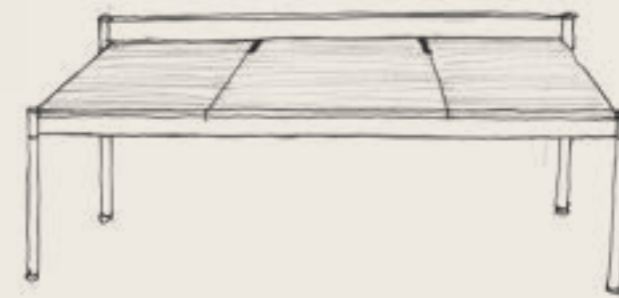
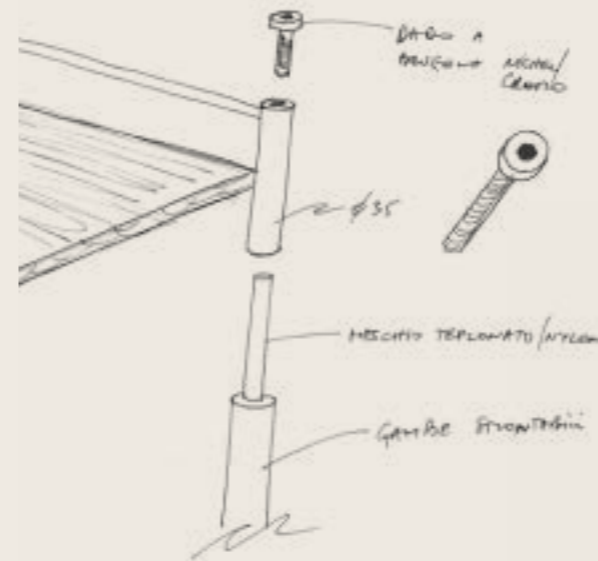

“

<sup>IT</sup> OMAGGIO ALLA SCRITTURA, YUKIO È UNO SCRITTOIO ELEGANTE E LEGGERO PENSATO PER AMBIENTARSI A TUTTI GLI AMBIENTI DELLA CASA.  
<sup>EN</sup> A TRIBUTE TO WRITING, YUKIO IS A LIGHT, ELEGANT DESK DESIGNED TO FIT IN ANY ROOM IN THE HOUSE.

Gordon Guillaumier

”

“

<sup>IT</sup> LA PARTICOLARITÀ DI TSUKI È L'IMMAGINE LIBERA E ORGANICA DATA DALL'EFFETTO TRASLUCIDO DEL PIANO IN VETRO SATINATO CHE LASCIA TRASPARIRE LA FORMA IRREGOLARE DELLA SOTTOSTANTE STRUTTURA IN METALLO CREANDO UN DELICATO GIOCO DI LUCE E OMBRA CHE RICORDA LE FASI LUNARI.  
<sup>EN</sup> THE DISTINCTIVE FEATURE OF TSUKI IS THE FREE, ORGANIC IMAGE CREATED BY THE TRANSLUCID EFFECT OF THE SATIN-FINISH GLASS TOP. IT ALLOWS THE IRREGULAR SHAPE OF THE METAL FRAME BELOW TO SHOW THROUGH, CREATING A DELICATE PLAY OF LIGHT AND SHADE, WHICH ECHOES THE PHASES OF THE MOON.

Gordon Guillaumier

”

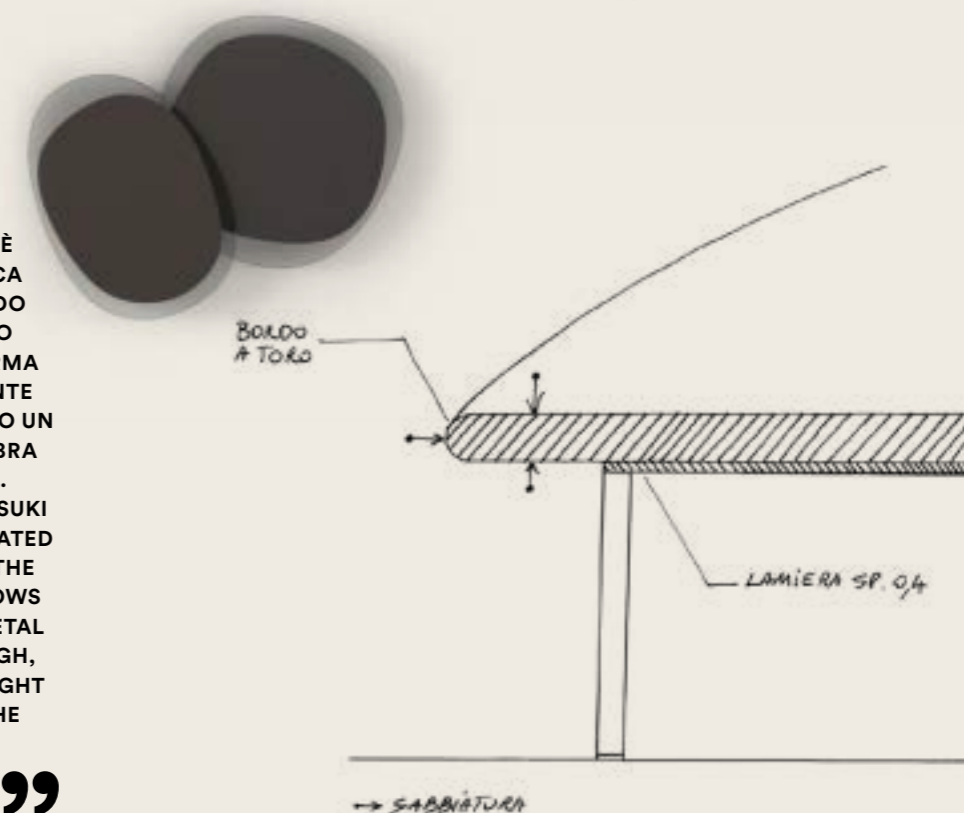



## RAFFAELLA MANGIAROTTI

<sup>IT</sup> Raffaella Mangiarotti è architetto e designer, vive e lavora a Milano. Si laurea in architettura, con un dottorato di ricerca in progettazione ambientale. È ricercatrice al Politecnico di Milano. Dopo una collaborazione con Marco Zanuso e Francesco Trabucco, fonda deepdesign, con Matteo Bazzicalupo, disegnando prodotti innovativi e di serie. Nel 2010 fonda lo studio Raffaella Mangiarotti dove si specializza in design di mobili, art direction, showroom e stand espositivi, progettando per brand a livello internazionale. Alcuni dei suoi prodotti sono esposti nei musei e fanno parte di collezioni permanenti, come il MoMA, e premiati con i più importanti premi internazionali. Nel 2017, 2018, 2021 e 2022 è stata nominata Ambasciatrice del Design Italiano nel mondo.

<sup>EN</sup> Raffaella Mangiarotti is an architect and designer who lives and works in Milan. She studied architecture and has a PhD in environmental design. She works as a researcher at Milan's Polytechnic University. After collaborating with Marco Zanuso and Francesco Trabucco, she founded deepdesign with Matteo Bazzicalupo, designing innovative and mass-produced products. In 2010, she founded the Raffaella Mangiarotti studio, where she specialises in furniture design, art direction, showrooms and exhibition stands, creating designs for international brands. Some of her products are exhibited in museums and are part of permanent collections such as the MoMA. Some have also won important international awards. In 2017, 2018, 2021 and 2022, she was appointed global Ambassador of Italian Design.



“  
<sup>IT</sup> NOBU È UN VERO PEZZO JOLLY DELLA CASA, PENSATO PER LA NOTTE MA PERFETTO IN TUTTI GLI AMBIENTI PER LA SUA NATURA LIBERA, LEGGERA E INFORMALE.  
<sup>EN</sup> NOBU IS A TRULY VERSATILE PIECE AROUND THE HOUSE, DESIGNED FOR THE BEDROOM BUT PERFECT IN ALL AREAS BECAUSE IT IS FREE, LIGHT AND INFORMAL.

Raffaella Mangiarotti

”



## BRUNA VACCHER

<sup>IT</sup> Inizia l'attività professionale nel 1990, dopo la laurea in architettura presso lo IUAV di Venezia e fonda lo studio Modacasa atelier architettura. Molteplici sono le esperienze nel campo dell'architettura, direzione artistica e design nel settore dell'arredamento.

<sup>EN</sup> She began her professional career in 1990, after graduating in Architecture from the IUAV in Venice, founding Modacasa, an architectural studio. She has a wealth of experience in the fields of architecture, artistic management and furniture design.

“

<sup>IT</sup> RIGHETTO È UN LETTO RAFFINATO E SCENOGRAFICO CON TESTIERA/BOISERIE ATTREZZABILE CON LUCI E MENSOLINE IN METALLO.

<sup>EN</sup> RIGHETTO IS A SPECTACULAR, SOPHISTICATED BED WITH HEADBOARD/BOISERIE THAT CAN BE ACCESSORISED WITH LIGHTS AND PETITE METAL SHELVES.

Bruna Vaccher

”

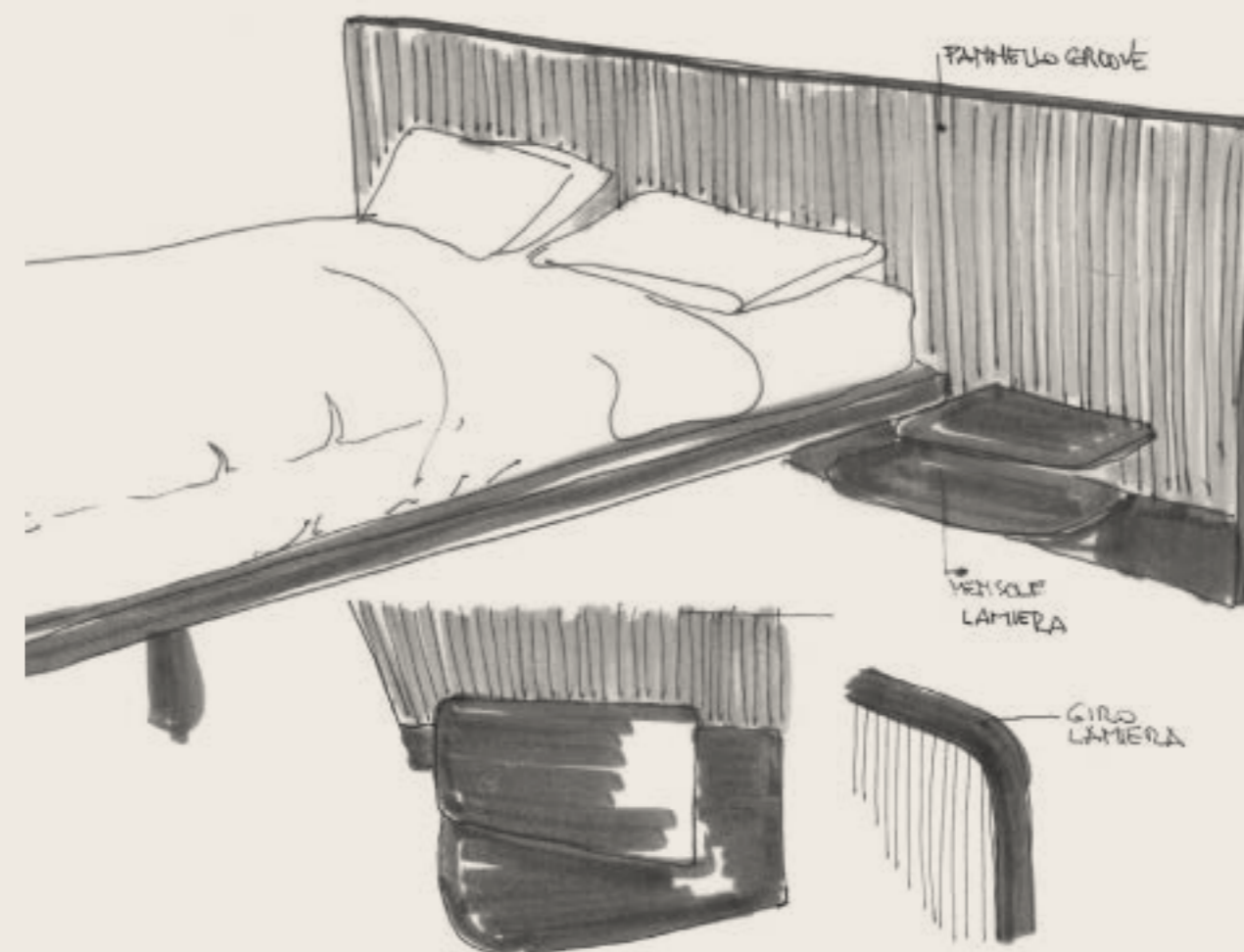



**IT** Le origini di Alf Group risalgono ai primi anni '50 quando un gruppo di artigiani del legno, di elevata esperienza e capacità, decide di riunirsi per fondare una cooperativa a Francenigo (Treviso). Già dopo pochi anni, questo primo nucleo diventa una realtà industriale di rilievo nel panorama del settore, tanto da spingere i fratelli Piovesana a rilevare l'azienda e ad investire nuove risorse. I risultati del loro impegno non si fanno attendere: già dai primi anni '60 Alf si espande, grazie alla propria capacità di distinguersi nella progettazione e nella realizzazione di arredi per la zona notte.

**EN** The origins of Alf Group date back to the early 1950s, when a group of artisan wood workers, with a wealth of experience and skills behind them, decided to come together to form a cooperative in Francenigo (Treviso, Italy). After just a few years, the initial team had become an important industrial presence in the sector, so much so that the Piovesana brothers were inspired to take over the whole company and invest in new resources. And the results did not take a long time to show: Alf began expanding in the early 1960s, thanks to its ability to distinguish itself in the bedroom furniture design and creation sector.

**IT** La cifra di 150.000 mq di spazi produttivi, dà la semplice misura fisica di un'azienda nella quale la tradizione familiare ed i valori umani sono i veri patrimoni. Ogni soluzione d'arredo del gruppo nasce dall'esperienza di decenni e dal lavoro di un team unito e motivato, in un'atmosfera positiva ed etica. La qualità Alf Group è il risultato del senso di responsabilità di ciascun addetto. Grazie alle sue tecnologie ed alla professionalità degli operatori, Alf Group garantisce la produttività e la flessibilità di un'azienda moderna, con in più la cura delle lavorazioni e le possibilità del su misura, che le derivano dalle sue radici artigianali.

**EN** The 150,000 m<sup>2</sup> expanse of production facility gives an idea of the physical size of the company, where family tradition and human values are considered the true company heritage. Every piece of furniture is created out of decades of experience and the work of a united and motivated team, in a positive and ethical environment. The quality offered by the Alf Group is the result of the sense of responsibility felt by each and every worker. Thanks to the use of technology and the professionalism of its workers, the Alf Group guarantees the productivity and flexibility of a modern company, together with the care for processing techniques and customisation options that come from its artisan origins.



**IT** Alf Group è una realtà italiana di rilievo nel panorama internazionale dell'arredamento. Protagonista di un'avventura imprenditoriale di grande successo, questa azienda ha fatto della ricerca della qualità e del miglioramento continuo la propria missione, interpretando con proposte sempre nuove gli spazi e gli stili di vita della contemporaneità. Alf DaFrè Il senso della bellezza, dell'armonia e della versatilità nella zona notte e nella zona giorno. Valdesign L'ambiente cucina con un gusto particolare per l'eleganza e la qualità. Alf Italia L'arredo Made In Italy dedicato a un pubblico internazionale.

**EN** Alf Group is an Italian company leading the way in the international furniture scene. As the star of a successful entrepreneurial adventure, this company has made the quest for quality and continuous improvement its mission, interpreting modern spaces and lifestyles with ever new products and ideas. Alf DaFrè: a feel for beauty, harmony and versatility in the bedroom and living area. Valdesign: kitchen spaces with a unique taste for elegance and quality. Alf Italia: made-in-Italy furniture for the international market.

**IT UN'AZIENDA CHE GUARDA  
ALLA SOSTENIBILITÀ  
EN A SUSTAINABILITY-ORIENTED  
COMPANY**

**IT AMBIENTE** Abbiamo ampliato il nostro stabilimento nel rispetto della natura, valutando gli impatti ambientali e realizzando un progetto sostenibile e consapevole.

**EN ENVIRONMENT** We have enlarged our premises in an environmentally conscious way, evaluating impact and implementing responsible and sustainable plans.





03



05



01



02



04

**RECYCLA**  
AGIRE RESPONSABILMENTE

**01** <sup>IT</sup> **MATERIALI** Prediligiamo l'uso di finiture all'acqua e materiali ecologici. I nostri pannelli sono a bassa emissione di formaldeide secondo normative EPA e CARB.  
<sup>EN</sup> **MATERIALS** We use water-based finishes and ecological materials. Our panels have low formaldehyde emissions according to the EPA and CARB regulations.

**02** <sup>IT</sup> **ACQUA** Attraverso interventi di messa in sicurezza idrogeologica, proteggiamo il territorio dagli allagamenti e tuteliamo la fauna e la flora locali.  
<sup>EN</sup> **WATER** Following various hydrogeological safety interventions, we are able to protect our area against flooding and safeguard the local flora and fauna.

**03** <sup>IT</sup> **EFFICIENZA ENERGETICA** Grazie alla razionalizzazione dei processi e delle utenze, abbiamo incrementato la nostra produttività mantenendo invariati i consumi di energia.  
<sup>EN</sup> **ENERGY EFFICIENCY** Thanks to efforts to streamline our processes and utilities, we have increased productivity without increasing energy consumption.

**04** <sup>IT</sup> **RIFIUTI** Continuiamo un percorso di raccolta differenziata spinta, recupero e riutilizzo delle materie prime, riciclo e ottimizzazione degli imballaggi.  
<sup>EN</sup> **WASTE** We continue to operate a strict waste-sorting policy, reclaim and reuse raw materials, recycle and optimise our use of packaging.

**05** <sup>IT</sup> **EMISSIONI** Oltre a controllare le emissioni in atmosfera, abbiamo migliorato la viabilità di accesso all'azienda e internalizzato alcune lavorazioni, per ridurre il traffico su strada.  
<sup>EN</sup> **EMISSIONS** In addition to monitoring emissions into the atmosphere, we have improved road access to our premises and moved some processing work in-house to reduce traffic on the roads.

<sup>IT</sup> **CODICE ETICO** Insieme alla tutela dell'ambiente, il benessere e la valorizzazione delle persone sono per noi dei principi fondamentali. Ecco perché ci siamo dotati di un Codice Etico che stabilisce i valori e i comportamenti sui quali si fondano la nostra attività e i nostri rapporti con dipendenti e collaboratori: per lavorare bene, in un mondo migliore.  
<sup>EN</sup> **CODE OF ETHICS** In addition to safeguarding the environment, two of our key principles are ensuring the wellbeing of our employees and promoting human resource development. This is why we have drawn up a Code of Ethics setting out the values and conduct which forms the basis of our business and our relationship with our employees and partners. We want to work well together, for a better world.



**ECOL DESIGN  
AWARD 2022  
WINNER**

<sup>IT</sup> Alf Uno Spa si aggiudica l'ECOL DESIGN AWARD 2022, premio per le eccellenze in ambito green assegnato da RECYCLA. Un riconoscimento pensato appositamente per premiare i Clienti più virtuosi che nell'anno si sono impegnati nella sostenibilità della propria Azienda, adottando tutte le misure per migliorarne le performance ambientali. Un attestato che vuole testimoniare la continua perseveranza nel disegnare e tracciare insieme a Recycla un percorso ecosostenibile che favorisca una corretta gestione dei rifiuti.

<sup>EN</sup> Alf Uno Spa wins the ECOL DESIGN AWARD 2022, an award for excellence in the field of environmental protection assigned by RECYCLA. Ecol design award 2022 is a recognition specifically designed to reward the most virtuous customers who have committed themselves to the sustainability of their company during the year, adopting all measures to improve its environmental performance. A certificate that testifies to the continuous perseverance in designing and tracing an eco-sustainable path together with Recycla that favors correct waste management.



# WORLD WIDE OFFICES

**CANADA & USA NORTH-EAST COAST**  
TEL. (416) 663-2223 - FAX (416) 663-2594  
E-MAIL: alf@rosnerinternational.com

**CENTRAL AMERICA - CARIBBEAN ISLANDS**  
TEL. (787) 786-9705 - FAX (787) 785-9835  
E-MAIL: alvin@arodz.net

**LOUISIANA - OKLAHOMA - TEXAS**  
TEL. (405) 204-4737  
E-MAIL: parke@furnituresourcetexas.com

**ARIZONA - OREGON - WASHINGTON - NORTHERN CALIFORNIA - ALASKA - COLORADO - UTAH - NEW MEXICO - HAWAII**  
TEL. (707) 291 2995  
E-MAIL: cornelussen@aol.com

**FLORIDA - ALABAMA**  
TEL. (321) 773-6982 - FAX (321) 773-8324  
E-MAIL: lloyddavisiii@aol.com

**MID-WEST / SOUTH-EAST (EXCLUDING FLORIDA)**  
TEL. (310) 636-1199 - FAX (310) 636-4433  
E-MAIL: bill@weisbergsales.com

**U.S.A.; HIGH POINT SHOWROOM**  
(OPEN ONLY DURING FURNITURE MARKET DATES)  
TEL. (336) 889-9027

**NEVADA - SOUTHERN CALIFORNIA**  
E-MAIL: alf@alf.it

**AUSTRALIA & NEW ZEALAND**  
TEL. (08) 9314 3999 - FAX (08) 9314 3777  
E-MAIL: rosa@merlino.com.au

**MEXICO**  
TEL. (55) 5351-1348  
E-MAIL: furniturezenteno@yahoo.com

**AUSTRIA**  
TEL. +43(0)4240 20358 - FAX +43(0)4240 20370  
E-MAIL: luca.zoldan@designphilosophy.org

**GERMANY**  
TEL. +49 171 8043908  
E-MAIL: roberto.sonego65@gmail.com

**SWITZERLAND**  
TEL. +39 342 776 0752  
E-MAIL: d.pagot@agentur2020.com

**DENMARK**  
TEL. +45 20475875  
E-MAIL: lehri@mail.dk

**BELGIUM - LUXEMBOURG**  
TEL. +32 471726845  
E-MAIL: jan@jmsa.be

**NETHERLANDS**  
TEL. +31-655-191753  
E-MAIL: arnold@hakse.com

**EAST EUROPE**  
TEL. +39 3484064921  
E-MAIL: caputomauro@libero.it

**ICELAND**  
TEL. +354 5880640  
E-MAIL: casa@casa.is

**U.K. - IRELAND**  
TEL. + 44 7980019194  
E-MAIL: design@atmosphere1102.com

**FRANCE - BRETAGNE - NORMANDIE - CENTRE**  
TEL. 0033608423974  
E-MAIL: contact@jmcsarl.fr

**FRANCE - EST**  
TEL. 0033615436985  
E-MAIL: ch.vidrin@wanadoo.fr

**FRANCE - SUD-EST**  
TEL. 06 33 83 87 58  
E-MAIL: fd.developpement@orange.fr

**FRANCE - ILE DE FRANCE - NORD**  
TEL. 06 60 65 61 62  
E-MAIL: decaix.christophe@wanadoo.fr

**FRANCE - SUD-OUEST**  
TEL. 06 40 55 21 88  
E-MAIL: tgjrerd.gtb@gmail.com

**FRANCE - RHONE/ALPES**  
TEL. 0033689923725 - FAX 0033466777294  
E-MAIL: fredericc.ac@orange.fr

**HELLAS - CYPRUS**  
TEL. +39 0434 778194 - FAX +43(0)4240 20370  
E-MAIL: luca.zoldan@designphilos ophy.org

**INDIA - SRI LANKA**  
TEL. +91 8041285290 - 91 9845636644  
E-MAIL: keith@kreb.in

**ALF GROUP MIDDLE-EAST REP. OFFICE**  
TEL. +961 4718160 - FAX +961 4718159  
E-MAIL: info@alfme.com

**POLAND**  
TEL. +48 618175994 - FAX +48 616429218  
E-MAIL: karina@qualitaitaliana.pl

**CSI E PAESI BALTICI**  
TEL. +7-812-3322934 - FAX +7-812-3322934  
E-MAIL: office.spb@alf.it

**ALGERIA - TUNISIA**  
E-MAIL: info@wallitaliandesign.it

**SOUTH AFRICA**  
TEL. +27 0861777123 - FAX +27 0118262186  
E-MAIL: les@alfsa.co.za

**SPAIN - ANDALUCIA Y EXTREMADURA**  
TEL. +34 958818744 - FAX +34 958302251  
E-MAIL: info@javiercastellon.com

**SPAIN - ASTURRIE Y GALIZIA**  
TEL. +34 609 08 08 48  
E-MAIL: info@alfredoaviles.com

**SPAIN - CASTILLA Y LEON**  
TEL. +34983541003 - FAX +34983541003  
E-MAIL: evaristorg@gmail.com

**SPAIN - CATALUNYA**  
TEL. +34 626742304  
E-MAIL: info@taringrup.com

**SPAIN - VALENCIA, MURCIA Y CASTILLA LA MANCHA**  
TEL. +34 607 210 185  
E-MAIL: jlhervas.vlc@gmail.com

**SPAIN - MADRID**  
TEL. +34 607 363 016 - FAX +34 91 351 57 27  
E-MAIL: e.sesenna@telefonica.net

**SPAIN - BARCELONA - ANDORRA - SORIA, LA RIOJA, MALLORCA, MENORCA, IBIZA, FORMENTERA Y ASTURIAS**  
E-MAIL: alf@alf.it

**SPAIN - ARAGÓN**  
TEL. +34 650236594 - FAX +34 976598600  
E-MAIL: davidmirandamoreno@gmail.com

**SPAIN - PAIS VASCO, LA RIOJA, NAVARRA Y CANTABRIA**  
TEL. +34 656 703 204  
E-MAIL: iruoffice@iruoffice.com

**PORTUGAL**  
TEL. +351 919 723 837  
E-MAIL: alice.barroso@mail.telepac.pt

**TURKEY**  
E-MAIL: alf@alf.it

**INDONESIA - SINGAPORE**  
TEL. +65 91214415  
E-MAIL: alberto.fantin@soluzioni.com.sg

**TAIWAN - COREA DEL SUD - GIAPPONE**  
TEL. 0082 1086862707  
E-MAIL: mattiazanini.alfitalia@gmail.com



Verifica le finiture disponibili sul nostro sito internet. / Check the finishes available on our website. / Consulte los acabados disponibles en nuestro sitio web. / Vérifiez les finitions disponibles sur notre site internet. / Überprüfen Sie auf unserer Webseite, ob die gewünschte Ausführung erhältlich ist. / Познакомьтесь с вариантами отделки на нашем интернет-сайте www.alfdafre.it

ALF UNO s.p.a. si riserva di apportare in qualsiasi momento modifiche a prodotti, misure e materiali, che ritenesse utili per esigenze di carattere produttivo e commerciale. Per essere sempre aggiornati vi invitiamo a consultare il nostro sito internet [www.alfdafre.it](http://www.alfdafre.it).

**LE FINITURE:** I materiali utilizzati dalla nostra azienda sono selezionati tra i più affidabili per applicazione e resa estetica. Nonostante questo devono considerarsi tollerabili alcune differenze dovute alle caratteristiche stesse di materiali come essenze naturali, vetri, laccature e all'artigianalità di alcune fasi del processo produttivo che da sempre è un nostro valore aggiunto. Inoltre alcune finiture possono subire nel tempo maturazioni dovute all'azione della luce e del tempo. È importante quindi specificare se nell'ordine vi sono sostituzioni o completamenti per valutare insieme il miglior modo di procedere. Le tonalità di colore e le finiture illustrate vanno considerate puramente indicative. Verificare sempre la fattibilità dell'abbinamento finiture consultando l'interno del listino.

ALF UNO s.p.a. reserves the right to make any changes to products, measurements and materials at any time deemed useful for manufacturing and sales purposes. To stay up to date at all times, please visit our website [www.alfdafre.it](http://www.alfdafre.it)

**FINISHES:** The materials we use are selected among the most reliable products in terms of application and aesthetic rendering. Despite this, certain differences due to the very characteristics of materials such as natural wood finishes, glass and lacquers must be considered tolerable, as well as the hand-crafted nature of certain phases of the production process, which has always been one of our added values. In addition, some finishes may change over time, due to the effects of light and time. It is therefore important to specify whether there are replacements or completions in the order to assess the best way to proceed together. The finishes featured in this sample collection are purely indicative and are not available for all products. Please check in the price list if the finish is available for the chosen item. Orders will not be accepted for products with finishes not included in the price list. The colour shades and finishes illustrated herein are to be considered purely indicative. Always check the feasibility of finish combinations by consulting the price list contents.

art direction **Bruna Vaccher, Genny Canton** / graphic **Genny Canton Studio** / photo **Riccardo Munarin** / digital image **Nudesign** / styling **Rosanna Bignucolo, Claudia Barberi** / separations **Lucegroup.it** / print **Sincromia** COM: 221809

## Alf DaFre®

ALF UNO Spa  
Via S. Pio X 17  
31018 Francenigo di Gaiarine  
Treviso, Italy  
Tel. +39 0438 997111  
Fax Italia +39 0438 997245  
Fax estero +39 0438 997246  
[www.alfdafre.it](http://www.alfdafre.it) alf@alf.it



ALF UNO Spa  
è certificata ISO 9001:2015  
ALF UNO Spa  
is certified by the ISO 9001:2015

